

Temperature Control for Research and Industry

Model 260/Timer User's Manual

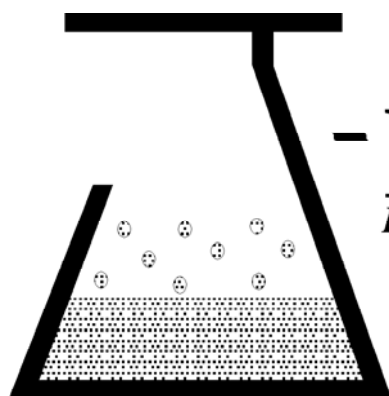

KEM Scientific, Inc.
Instruments for Science from Scientists

Warranty

J-KEM Scientific, Inc. warrants this unit to be free of defects in materials and workmanship and to give satisfactory service for a period of 12 months from date of purchase. If the unit should malfunction, it must be returned to the factory for evaluation. If the unit is found to be defective upon examination by J-KEM, it will be repaired or replaced at no charge. However, this WARRANTY is VOID if the unit shows evidence of having been tampered with or shows evidence of being damaged as a result of excessive current, heat, moisture, vibration, corrosive materials, or misuse. This WARRANTY is VOID if devices other than those specified in Section 3.2 are powered by the controller. Components which wear or are damaged by misuse are not warranted. This includes contact points, fuses and solid state relays.

THERE ARE NO WARRANTIES EXCEPT AS STATED HEREIN. THERE ARE NO OTHER WARRANTIES, EXPRESSED OR IMPLIED, INCLUDING BUT NOT LIMITED TO THE IMPLIED WARRANTIES OF MERCHANTABILITY AND OF FITNESS FOR A PARTICULAR PURPOSE. IN NO EVENT SHALL J-KEM SCIENTIFIC, INC. BE LIABLE FOR CONSEQUENTIAL, INCIDENTAL OR SPECIAL DAMAGES. THE BUYER'S SOLE REMEDY FOR ANY BREACH OF THIS AGREEMENT BY J-KEM SCIENTIFIC, INC. OR ANY BREACH OF ANY WARRANTY BY J-KEM SCIENTIFIC, INC. SHALL NOT EXCEED THE PURCHASE PRICE PAID BY THE PURCHASER TO J-KEM SCIENTIFIC, INC. FOR THE UNIT OR UNITS OF EQUIPMENT DIRECTLY AFFECTED BY SUCH BREACH.

Service

J-KEM Scientific maintains its own service facility and technical staff to service all parts of the controller, usually in 24 hours. For service, contact:

J-KEM Scientific, Inc.
6970 Olive Boulevard
St. Louis, MO 63130 USA
(314) 863-5536
FAX (314) 863-6070
Web site: <http://www.jkem.com>
E-Mail: jkem911@jkem.com

This manual contains parameters specific to temperature controller Serial # _____.
When calling with a technical question, please have the controller's serial number available.

You've purchased the most versatile controller available to the research community. We're confident it can regulate ANY heating/cooling situation you'll ever encounter. If the information in this manual isn't adequate to make your application work, call our Engineering Department for assistance.

– With J-KEM's patented Microtune circuitry –

INDEX

| <u>SECTION</u> | <u>PAGE</u> |
|--|-------------|
| 1. QUICK OPERATING INSTRUCTIONS | 4 |
| KEM-NET DATA LOGGING AND CONTROL SOFTWARE | 5 |
| 2. ADJUSTING THE CONTROLLER FOR STABLE CONTROL WITH VARIOUS HEATERS | 6 |
| 2.1 What is Tuning | 6 |
| 2.2 Autotuning Procedure | 7 |
| 2.3 Tuning for Heating Mantles: A Special Case | 9 |
| 2.4 Sensor Placement | 9 |
| 3. OPERATIONS GUIDE | 10 |
| 3.1 Front Panel Description | 10 |
| 3.2 Heater Restrictions | 11 |
| 3.3 Ramp-to-Setpoint & Soak Feature | 12 |
| 3.4 Temperature Sensor Input | 14 |
| 3.5 Timer Controls | 15 |
| 3.6 Over Temperature Protection Circuit | 19 |
| 3.7 Power Reduction Circuit | 19 |
| (Selecting the right power setting) | |
| 3.8 Affect of Power Setting on Heating Profile | 21 |
| 3.9 Do's and Don'ts When Using Your Controller | 22 |
| 3.10 Resetting the Controller for use With Heating Mantles | 23 |
| 3.11 Changing the Temperature Display Resolution | 24 |
| 3.12 Changing Between PID and ON/OFF Operating Modes | 24 |
| 3.13 Troubleshooting | 25 |
| 3.14 Fusing | 26 |
| 4. APPLICATION NOTES | 27 |
| 4.1 Theory of How the Controller Works – Simply | 27 |
| 4.2 Controlling the Heating Mantle Temperature Directly | 28 |
| 4.3 Automatic Storage of Min/Max Temperatures | 29 |
| TABLE 1 | 30 |
| APPENDIX | 31 |
| I. Using the Controller with Oil Baths (Application Note 1) | 31 |
| II. Safety Considerations and Accurate Temperature Control | 32 |
| III. Resetting the Controller to Original Factory Settings | 33 |

| |
|---|
| <u>WARNING:</u> Adhere to the restrictions of SECTION 3.2 . Failure to do so may create a significant safety hazard and will void the warranty. |
|---|

Section 1: Quick Operating Instructions

The five steps below are the basics of using your temperature controller. The User's Manual is a reference that explains the controller more fully as well as some of its more sophisticated features. It's recommended that new users unfamiliar with process controllers read the entire manual carefully. **The controller is preprogrammed for use with heating mantles fitted to round bottomed flasks running "typical" organic reactions**

(i.e., non-polymeric, non-exothermic reactions in solvents such as THF, toluene, DMF, etc.). If the controller is used with this type of reaction, the five steps below will help you get started.

To use heaters other than heating mantles:

See Section 2.

Do not use the controller to heat oil baths:

See Section 3.2 & Appendix I.

For polymer synthesis, atypical, expensive, or safety critical reactions:

See Appendix II.

1 Set the over temperature protection circuit to "Off".

The switch for the over temperature protection circuit must be set to the "Off" position until the setpoint for the reaction is entered into the digital meter. After entering the setpoint in Step 4, the over temperature protection circuit can be turned on if desired by setting this switch to the "Alarm" or "Light" position. See Section 3.6.

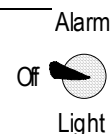

2 Place the thermocouple in the solution being heated.

Place at least the first 1/2" of the thermocouple directly in the solution being heated. Thermocouples can be bent without harming them. If you're heating a corrosive liquid, use a Teflon coated thermocouple. If you are heating a sealed reaction, see Section 4.2.

3 Set the power level switch to the volume of solution being heated

(not the size of the flask being used).

The power level switch can be thought of as a solid state variac. Volume ranges are printed above this switch as a guide to select the correct power level since it's easier to guess the volume being heated than the appropriate "percent power" to apply to a heater. 'Heat Off' turns off the heater so the controller displays temperature only. All new users should read Section 3.7.

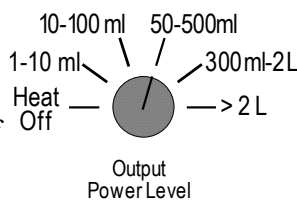

| A power setting of..... | is equivalent to a variac setting of: |
|-------------------------|---------------------------------------|
| 1-10 ml | 3% |
| 10-100 ml | 10% |
| 50-500 ml | 25% |
| 300 ml - 2 L | 50% |
| > 2 L | 100% |

TIP: Because the power switch acts like a variac, if the reaction is heating too slowly or you need more power (e.g., heating to high temperatures), give the heater more power by turning the power level up one setting. If the reaction needs less power than normal (e.g., heating to low temperatures (<60° C) or the temperature overshoots the set point excessively, turn the power down one setting. **DO NOT** set the power switch on a setting too high initially to heat the reaction quickly and then lower it to the correct setting, this degrades heating performance.

4 Enter the setpoint (i.e., the desired temperature).

Hold in the * button and simultaneously press the ▲ key to increase or the ▼ key to decrease the setpoint. The setpoint can be seen at anytime by holding in the * button, the setpoint appears as a blinking number in the display.

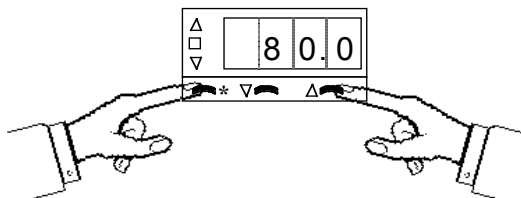

5 Set the timer.

When power is applied to the controller, by default, the timer turns power OFF to the heater as a safety precaution



To turn power On to the heater, briefly push in on the round timer knob and the display changes to ON to show that power to the heater is ON. For complete instructions on the user of the timer see the section titled *Timer Controls*. If the display does not change when the timer knob is pressed, make sure that the Power Level Switch is not set to the "Heat Off" position.



KEM-Net Data Logging and Control Software

At the beginning of 2008, J-KEM implemented a redesign of its research grade temperature and vacuum controllers. The redesign involved both the hardware running your controller and software for remote control and data logging.

Hardware – The controller may look the same, but inside is our 3rd generation microcontroller. This controller is FLASH programmable and capable of downloading *program modules*(software) from our web site at no charge. Several program modules are in development, but the most exciting is a module that automatically reports exothermic reactions – even during the heating phase of a reaction when an exotherm would normally be undetectable.

Software - Your controller is equipped with a USB port to allow remote control and data logging. J-KEM is currently developing a complementary software package, **KEM-Net**, that remotely controls and data logs up to 16 controllers simultaneously. Until KEM-Net is available, J-KEM is offering KEM-Log at no charge.

| <p>KEM-Log provides remote control and data logging for one J-KEM controller. KEM-Log implements:</p> <ul style="list-style-type: none">* Data logging directly to Excel or a text file.* A 16-step temperature ramp that's constructed in an Excel-like table.* Easy entry of the setpoint | <table border="1"><thead><tr><th>Step</th><th>Starting Temperature (oC)</th><th>Ending Temperature (oC)</th><th>Ramp Rate (Deg/Hr)</th><th>Hold Time (Hr)</th></tr></thead><tbody><tr><td>1</td><td>25</td><td>120</td><td>80</td><td>0.5</td></tr><tr><td>2</td><td>120</td><td>100</td><td>40</td><td>0</td></tr><tr><td>3</td><td>100</td><td>45</td><td>120</td><td>1</td></tr><tr><td>4</td><td>45</td><td>-5</td><td>1000</td><td>0</td></tr></tbody></table> | Step | Starting Temperature (oC) | Ending Temperature (oC) | Ramp Rate (Deg/Hr) | Hold Time (Hr) | 1 | 25 | 120 | 80 | 0.5 | 2 | 120 | 100 | 40 | 0 | 3 | 100 | 45 | 120 | 1 | 4 | 45 | -5 | 1000 | 0 |
|---|---|-------------------------|---------------------------|-------------------------|--------------------|----------------|---|----|-----|----|-----|---|-----|-----|----|---|---|-----|----|-----|---|---|----|----|------|---|
| Step | Starting Temperature (oC) | Ending Temperature (oC) | Ramp Rate (Deg/Hr) | Hold Time (Hr) | | | | | | | | | | | | | | | | | | | | | | |
| 1 | 25 | 120 | 80 | 0.5 | | | | | | | | | | | | | | | | | | | | | | |
| 2 | 120 | 100 | 40 | 0 | | | | | | | | | | | | | | | | | | | | | | |
| 3 | 100 | 45 | 120 | 1 | | | | | | | | | | | | | | | | | | | | | | |
| 4 | 45 | -5 | 1000 | 0 | | | | | | | | | | | | | | | | | | | | | | |

KEM-Log is free of charge. To load KEM-Log to your PC, follow these steps:

1. Enter this link in your web browser: <http://www.jkem.com/kemnetzip.exe>
A popup window appears presenting the options of RUN, SAVE and CANCEL. Selecting the SAVE option brings up a Save File Dialog window. Save the file kemnetzip.exe to your C drive, then exit your web browser.
2. Kemnetzip.exe is a self-extracting zip file. Double click on its icon to expand it. Once expanded, kemnetzip.exe creates a new folder on your C drive titled "JKEM" which contains the KEM-Net Installation Project and copies of user's manuals and USB drivers.
3. Print the document titled PrintMe_Now.pdf for instruction on how to install the USB drivers and the KEM-Net software.

Section 2: Adjusting The Controller For Stable Control With Different Heaters

2.1 What is Tuning. The controller's most powerful feature is its ability to regulate virtually any heater with stable temperature control. For stable control the controller requires two things; (1) the controller must be set to the correct power level (see Section 3.7) and, (2) that it must be *tuned* to the heater being used. Tuning is the process that matches the control characteristics of the controller to the heating characteristics of the heater. The controller is said to be tuned to the heater when its memory is programmed with values representing how fast the heater warms up, cools off, and how efficiently it transfers heat. For example, consider the difference between a heat lamp and a hot plate. When electricity is applied to a heat lamp it begins to heat instantaneously, and when it's turned off it stops heating instantaneously. In contrast, a hot plate may take several minutes to begin heating when electricity is applied and even longer to stop heating when electricity is turned off. Your controller can regulate both a heat lamp and a hot plate to 0.1° C. But, to do this it must be programmed with the time constants appropriate for the heater in use. These time constants are called the *tuning parameters*.

Every type of heater has its own unique set of tuning parameters. For the controller to heat with stability, it must be programmed with the tuning parameters for the heater currently being used. Prior to shipping, tuning parameters were programmed into the controller that maximize heating performance for laboratory heating mantles since these are the most common heaters used in research. Tuning is regulated by 5 of the temperature meter's user programmable functions. The correct value for these 5 functions can be calculated and loaded by the user manually, or the controller can do it automatically with its autotune feature.

When Should the Controller be Tuned? If the controller is tuned to one type of heater, heating mantles for example, any size heating mantle can be used without the need to retune. When changing from heating mantles to a different type of heater, an oven for example, the controller should be tuned with values describing the oven's heating characteristics. The effect of tuning is seen below. When the controller is tuned for heating mantles, using it with any size heating mantle yields stable temperature control (Plot 1), but poor control results when the same tuning parameters are used with an oven (Plot 2, Curve 1). However, after tuning the controller to the oven, stable temperature control results (Plot 2, Curve 2).

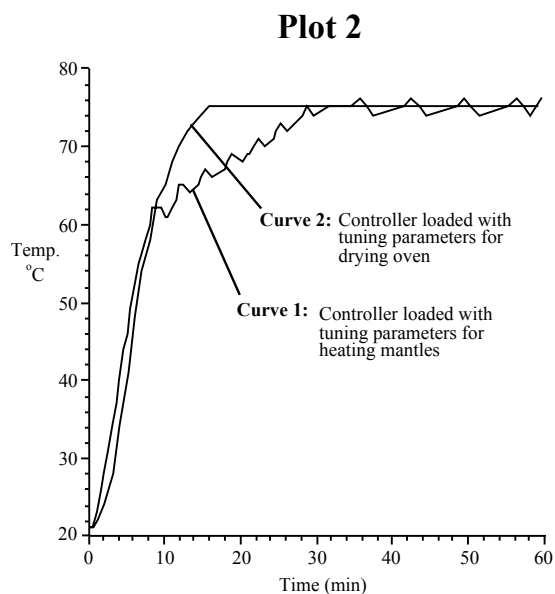
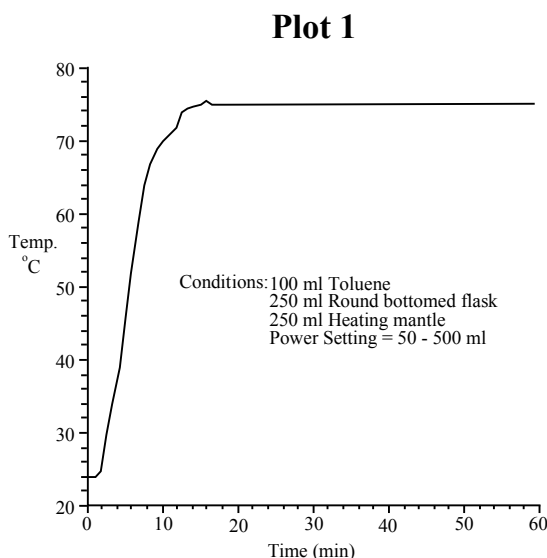

It's important to understand that this controller isn't a simple ON/OFF type controller (i.e. ON when below the set point, OFF when above [though it can be made to work this way, see Section 3.12]). Rather it's a *predictive* controller. Based on the shape (slope) of the heating curve, the controller predicts (calculates) the percent of power to apply to the heater now to control the shape of the heating curve minutes in advance. The importance of the tuning parameters is that they are constants in the equation the temperature meter uses to perform its predictive calculations. If the temperature meter is programmed with tuning parameters that incorrectly describe the heater being used, poor temperature control will result. But, when the correct values are loaded, temperature regulation of $\pm 0.1^\circ$ is typically achieved.

Manual Tuning. Manual tuning is when the values of the 5 tuning parameters are determined manually then entered into the temperature meter via the push buttons on the front of the controller. Experienced users might prefer to manually tune the controller since this allows customization of the heating process.

Autotune. Autotune is a feature built into the temperature meter that automatically calculates the tuning parameters (i.e. delay times, heating efficiency, etc.) for any type of heater. After the autotune procedure is complete the controller automatically stores the tuning parameters in non-volatile memory. Heating mantles are a special case and are covered in a separate paragraph (Section 2.3).

2.2 Autotuning Procedure.

This procedure is not recommended for heating mantles (see Section 2.3).

1. Set the equipment up in the exact configuration it will be used. For example, to tune to a vacuum oven, place the thermocouple in the room temperature oven and plug the oven into the controller. If the oven (or heater) has its own thermostat or power control, turn both as high as they'll go.
2. Set the controller to the appropriate power level (see Section 3.7). Make sure the timer circuit is set to ON (i.e., the timer window displays On; see Section 3.5). Turn the Over Temperature Protection Circuit (7) to the OFF position. Turn the controller and heater on, and enter the desired set point temperature. If the set point isn't at least 30° C above ambient, skip this procedure and go to the next procedure, "[Autotuning the Controller for Very Fine Control](#)"
3. Press and hold in both the ▼ and ▲ buttons (for 3 seconds) on the front of the temperature meter until the word "**tunE**" appears in the display then release both buttons.
4. Press the ▲ button (5 times) until "**CyC.t**" appears in the display (if you go past this setting, press the ▼ button until you get back to it).
5. First, hold in the '*' button, while holding in the '*' button press the ▼ button. Continue to hold both buttons in until the display reads "**A --**", or "**A ##**" where "**##**" is some number.
6. Release the '*' button and press the ▼ button until "**tunE**" once again appears in the display.
7. Press and hold the '*' button and "**tunE**" will change to "**off**" to indicate that autotune is currently off.
8. While holding in the '*' button, press the ▲ button to change the display to "**on**", then release both buttons.
9. Press and hold both the ▲ and ▼ buttons (for 3 seconds) until the temperature appears in the display. The controller is now in its autotune mode. While in autotune the display alternates between "**tunE**" (for autotune) and the process temperature. When the autotune sequence is done (this may take in excess of an hour) the controller stops displaying "**tunE**" and only displays the process temperature. [To abort autotune manually, repeat steps 3, 8 and 9 except in step 8, press the ▼ button until "**off**" is displayed].

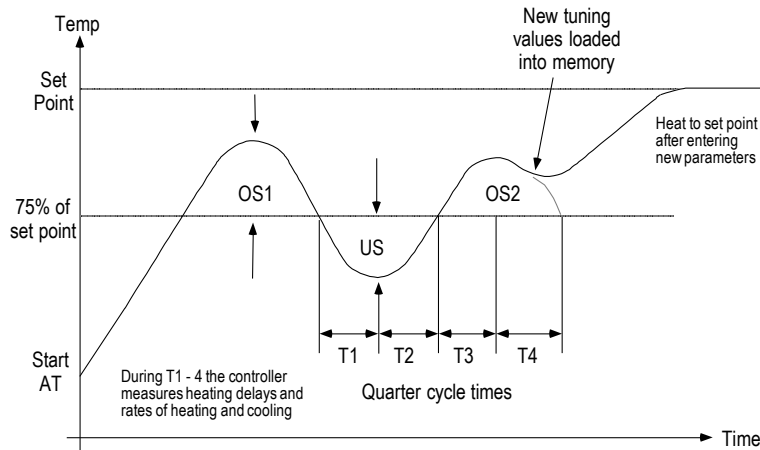

The autotune sequence.

During autotune the controller heats to 75% of the set point temperature where it oscillates for several cycles before loading the new tuning parameters. After the tuning parameters are loaded it heats to the set point temperature. Tuning below the set point prevents any damage that might occur from overheating.

Autotuning the Controller for Very Fine Control.

This procedure is not recommended for heating mantles (see Section 2.3).

In the majority of cases, the normal autotune procedure results in stable temperature control with any heater. A second version of the autotune routine is available and can be used when the heater is 1) at the set point, 2) is being tuned close to room temperature, or 3) for very fine control in demanding situations. If stable temperature control doesn't result after performing the first autotune routine, the procedure below should be performed. Before performing the 'fine tune' autotune procedure, if possible, perform the autotune procedure on the preceding page.

1. Set the equipment up in the exact configuration it will be used. If the heater has its own thermostat or power controls, turn both as high as they'll go. With this procedure it's not necessary for the equipment to start at room temperature. This procedure can be performed at any time and any temperature.
2. Set the controller to the appropriate power level (see Section 3.7). Make sure the timer circuit is set to ON (i.e., the timer window displays On; see Section 3.5). Turn the Over Temperature Protection Circuit (7) to the OFF position. Turn the controller and heater on then, enter the desired set point temperature.
3. Press and hold in both the ▲ and ▼ buttons (for 3 seconds) on the front of the temperature meter until the word "tunE" appears in the display then release both buttons.
4. Press the ▲ button (5 times) until "CyC.t" appears in the display (if you go past this setting, press the ▼ button until you get back to it).
5. First hold in the '*' button, while holding in the '*' button press the button. Continue to hold both buttons in until the display reads "A --", or "A ##" where "##" is some number.
6. Release the '*' button and press the ▼ button until "tunE" once again appears in the display.
7. Press and hold the '*' button and "tunE" will change to "off" to indicate that autotune is off.
8. While holding in the '*' button, press the ▲ button to change the display to "At.SP", and release both buttons.
9. Press and hold both the ▲ and ▼ buttons (≈ 3 seconds) until the temperature appears in the display. The controller is now in its autotune mode. While in autotune the display alternates between "tunE" (for autotune) and the process temperature. When the autotune sequence is done (this may take in excess of an hour) the controller stops displaying "tunE" and only displays the process temperature. [To abort autotune manually, repeat steps 3, 8 and 9 except in step 8, press the ▼ button until "off" is displayed].

Autotune Errors. The autotune routine can fail for several reasons. If it fails, the controller displays the error message “tunE” “FAiL”. To remove this message turn the controller off for 10 seconds. Try the procedure titled “Autotuning the Controller for Very Fine Control” above. If autotune fails again, call and discuss your application with one of our engineers. A common problem when tuning at high temperatures or with large volumes is for the heater to be underpowered. A more powerful heater may be needed (contact J-KEM for assistance).

2.3 Tuning for Heating Mantles: A Special Case. This section gives special consideration to heating mantles, since they’re the most common heaters used in research. Every heating mantle size has its own optimum set of tuning parameters and if you wanted, the controller could be tuned (or autotuned) every time a different size was used. However, this is cumbersome and is also unnecessary. Factory tests show that there’s a set of tuning parameters that delivers good performance for all heating mantle sizes. These tuning parameters were loaded into the controller at the factory prior to your receiving it. If you’re using a heating mantle and none of the parameters have been changed or the controller hasn’t been autotuned since you’ve received it, you’re ready to go. If the tuning parameters have been changed or the controller has been autotuned and you want to go back to using heating mantles, perform the procedure below to manually load the tuning parameters for heating mantles.

Procedure 1. Perform when using **heating mantles** with round bottomed flasks.

[This procedure takes about 2 minutes to perform]

| | |
|---|---|
| 1 | Press and hold in both the ↓ and ↑ keys on the front of the temperature meter until the word “tunE” appears in the display, then release both keys. |
| 2 | Press the ↑ key once and the word “bAnd” will appear in the display. First hold in the ‘*’ key, then while holding in the ‘*’ key press the ↓ or ↑ key until the value “10” appears, then let go of all the keys. |
| 3 | Press the ↑ key once and the word “int.t” will appear in the display. First hold in the ‘*’ key, then while holding in the ‘*’ key press the ↓ or ↑ key until the value “10” appears, then let go of all the keys. |
| 4 | Press the ↑ key once and the word “dEr.t” will appear in the display. First hold in the ‘*’ key, then while holding in the ‘*’ key press the ↓ or ↑ key until the value “50”, then let go of all the keys. |
| 5 | Press the ↑ key once and the word “dAC” will appear in the display. First hold in the ‘*’ key, then while holding in the ‘*’ key press the ↓ or ↑ key until the value “3.0”, then let go of all the keys. |
| 6 | Press the ↑ key once and the word “CyC.t” will appear in the display. First hold in the ‘*’ key, then while holding in the ‘*’ key press the ↓ or ↑ key until the value “30”, then let go of all the keys. |
| 7 | Press and hold in both the ↓ and ↑ keys until the temperature appears in the display, then release both keys. |

2.4 Sensor Placement. Placement of the sensor is basically common sense. The sensor should be positioned to sense the average temperature of the medium being heated. That means the thermocouple should be shielded from direct exposure to the heater but not so distant that a rise in temperature isn’t sensed by the controller within a reasonable period of time. Several examples follow that show the type of consideration that should be given to sensor placement.

| Use With: | |
|--|---|
| Solutions | Place the sensor <u>in</u> the solution. Stir vigorously so that heat is homogeneously mixed throughout the solution. |
| HPLC column heated with a heating tape | Tape a thin wire thermocouple directly to the HPLC column. Place several layers of paper over the thermocouple to insulate it from the heating tape (the thermocouple should sense the <u>column</u> temperature, not the heater temperature). Wrap the HPLC column completely with heating tape. |
| Oven | The thermocouple needs to be shielded from transient hot and cold air currents. Don’t place the thermocouple near the heating coil or an air vent. A small thermocouple (1/16” or 1/8” thermocouple) that responds rapidly to changes in air temperature is better than a larger one. |

Section 3: Operations Guide

3.1 Front Panel Description.

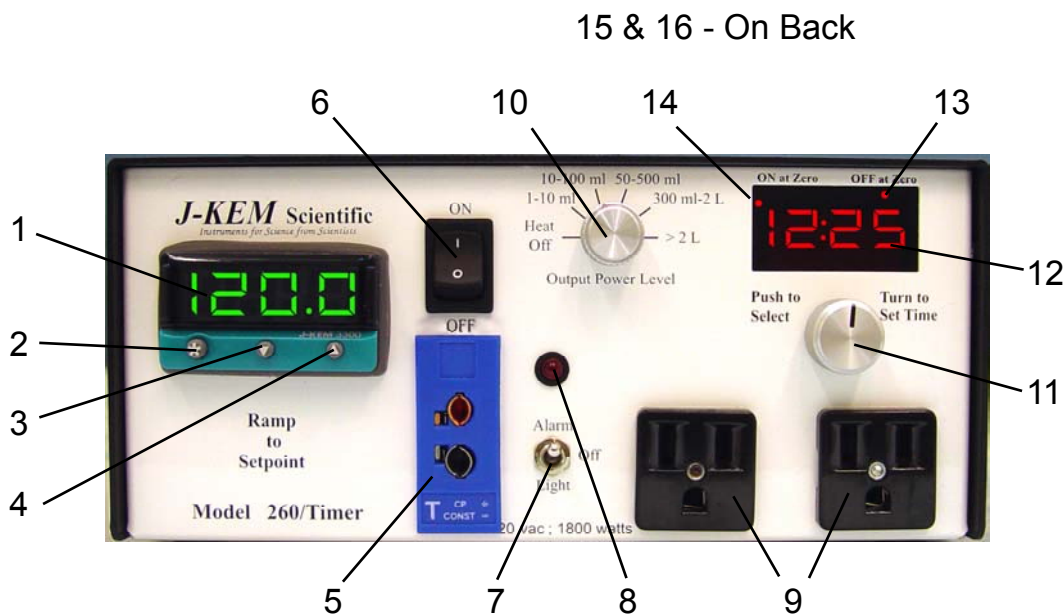

Figure 1

1. Temperature Display. Shows temperature of the process as the default display. Shows set point temperature (i.e. the desired temperature) when '*' (2) button is pressed.
2. Control Key. When pressed, the display shows the set point temperature. To decrease or increase the set point, press the ▼ key (3) or ▲ key (4) while simultaneously pressing the control key. The set point appears as a blinking number in the display.
3. Lowers the set point when '*' button (2) is simultaneously pressed.
4. Raises set point when '*' button (2) is simultaneously pressed.
5. Temperature Sensor Input. Use the same type of thermocouple as the sensor plug installed on the controller (see Section 3.4). The correct sensor type will have the same color plug as the receptacle (5) on the front of the controller.
6. Controller On/Off switch. For maximum accuracy of the displayed temperature, turn the controller on 15 minutes prior to use. **WARNING:** Due to the nature of solid-state relays, a small amount of output power (7.5 mA @ 120 VAC; 0.9 watts) is present at outlets (9) even when the controller is turned off. Take precautions to avoid electrical shock.
7. Over Temperature Protection Circuit. This switch must be in the Off position when the controller is powered up and going through its self-test routine, otherwise no power is delivered to the outlets. When turned on by switching to the Alarm or Light positions an over temperature condition (factory programmed for 5.0° C above the set point) will remove all power from outlets (9) until being manually reset by turning power to the controller off.
8. Alarm Light. Indicates an over temperature condition when lit. See Section 3.6.
9. Power Outlets. Plug only 120 VAC devices into these outlets. See Section 3.2.
10. Power Reduction Circuit. Interfaces to the power reduction computer that limits the maximum power delivered to the heater. See Sections 3.7 and 4.1.

11. **Timer Function Knob.** Multi-function knob that selects timer function (push knob in) and enters the amount of time in the timer (rotate). See Section 3.5.
12. **Timer Display.** The timer display always shows the status of the timer circuit (see Section 3.5). The display can show “On” meaning that the circuit will allow power to be applied to the heater, “Off”, meaning that the circuit will not allow power to be applied to the heater, or it will show a time when power will be applied or removed from the heater depending on the settings in the timer.
13. **Timer Status LED’s** Timer status LED’s indicate whether power will be applied or removed from the heater when the time in the timer goes to 0. See Section 3.5.
14. **Heater Status LED.** This (small) LED is On when power is being applied to the heater and Off when power is not applied to the heater.
15. **Over temperature audible alarm.** Sounds during an over temperature condition when switch (7) is set to the “alarm” position. To turn a sounding alarm off, momentarily turn power off to the controller.
16. **Optional Serial Port.** For controllers equipped for serial communications, this port connects to a PC for remote control and data acquisition. Controllers equipped for RS232 communications have a 9-pin connector; RS485 multi-drop controllers have a RJ-11 phone connector. See supplemental Serial Communications Manual.

3.2 Heater Restrictions. The controller delivers 15 amps of current at 120 VAC into resistive loads (heating mantles, hot plates, ovens, etc.). **Use only resistive loads that are safely operated at 120 VAC and require less than 15 amps or damage to the controller and a safety hazard may result.**

- **Only 120vac oil baths should be used with this controller.** Other voltage oil baths should be operated using J-KEM’s Model 410 controller (See Appendix for an application note describing how to use any voltage oil bath with this controller).
- Devices other than resistive loads can be used with your controller but certain restrictions apply.

| Device Type | Restrictions | Comments |
|---|---|---|
| Incandescent lamps Infrared heaters | ≤ 1200 watts | Set the power reduction circuit to the > 2 L position. |
| Inductive loads: * solenoids * transformers * motors | ≤ 6 amps; 720 watts $\leq 1/3$ horsepower | The controller must be programmed for this use. Request application note AN5. |

3.3 Ramp-to-Setpoint & Soak Feature. A new feature of J-KEM's controllers called 'Ramp-To-Setpoint' allows you to enter a specific heating rate (e.g., heat to 120⁰ C at a rate of 5⁰ C/Hour), a second feature called 'Soak' then lets you specify how long to stay at that temperature before turning off.

Examples of Program Ramps

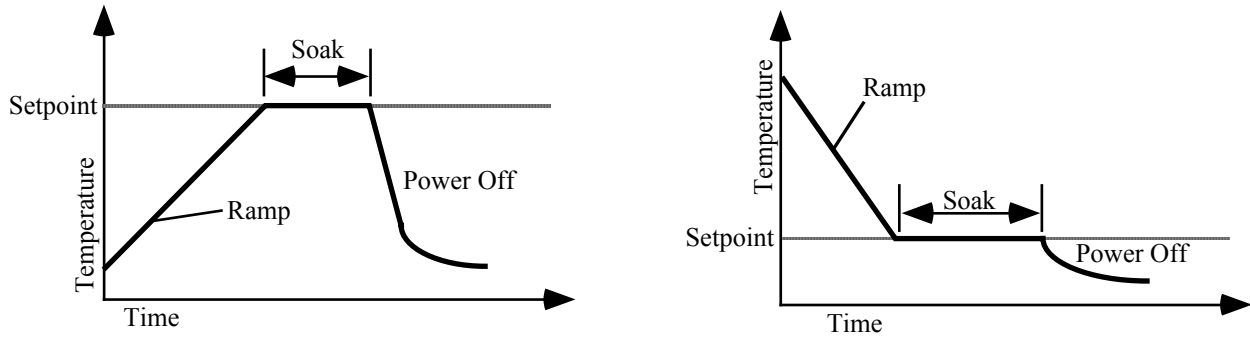

The controller is shipped with the Ramp-to-Setpoint feature OFF, the user must specifically turn Ramp-to-Setpoint ON. When Ramp-to-Setpoint is OFF, the controller heats to the entered setpoint at the fastest rate possible. When Ramp-to-Setpoint is ON, the controller heats at the user entered ramp rate.

The Ramp-to-Setpoint feature and its associated parameters are turned on and set in the controller's programming mode. The parameters of importance are:

SPrr SetPoint Ramp Rate. Allowable Values: 0 to 9990 deg/Hr.

This specifies the desired rate of heating (cooling). Note, this parameter specifies the *desired* rate of heating (cooling), but in cases of extremely high ramp rates the reaction will not actually heat faster than the power of the heater will allow.

SPrn SetPoint Ramp Run. Allowable Values: ON, OFF, Hold

This parameter turns the Ramp-to-Setpoint feature ON or OFF. During an active run, if this parameter is set to 'Hold', the setpoint ramp stops and *holds* at its' current value. This continues until the parameter is set to ON or OFF. When set to OFF, the values in SetPoint Ramp Rate and Soak Time are ignored.

SoAK Soak Time. Allowable Values: "- -", 0 to 1440 min.

This specifies the amount of time to *soak* at the setpoint after the setpoint temperature ramp is complete. A setting of "- -" causes the controller to remain at the final setpoint indefinitely. A numeric value causes the controller to stay at the setpoint for the entered time and then turn power to the heater off after the time expires.

Important Points to Know

1. While the Ramp-to-Setpoint feature is activated, the display alternates between the current reaction temperature and the word "**SPr**" to indicate that a "SetPoint Ramp" is active.
2. This controller is equipped with a digital 100-hour timer, the digital timer and the Ramp-to-Setpoint feature are completely independent of each other. For example, if the digital timer is set to turn heating OFF after 5 hours, heating **is** turned off even if a ramp step is in progress. Likewise, if a Soak time turns heating off after 3 hours and the digital timer is set to turn heating off after 10 hours, the digital timer has no effect since the expired Soak time already has turned heating off. To avoid confusion and conflicts between the meters "Hold" feature and the front panel digital timer, it's recommended that the Soak Time feature be set to "- -" in the meters setup menu and not changed.
3. Setting a ramp rate will not guarantee that the reaction temperature is at the specified ramp temperature since heating is dependent on the power of the heater. For example, if a ramp rate of 1200 deg/Hr (i.e., 20 deg/min) is set, unless the heater is powerful enough to impart heat at such a high rate, the reaction temperature will not track the ramp temperature. Likewise, a reaction can't cool faster than natural cooling by ambient air.
4. Once the Ramp-to-Setpoint feature is activated in programming mode, it remains on until it's deactivated in programming mode. The Ramp-to-Setpoint feature remains activated even if power is turned off to the controller.

Activating & Programming the Ramp-to-Setpoint Feature

| | |
|----|---|
| 1. | Press and hold in both the ▲ and ▼ keys on the front of the temperature meter until the word “ tunE ” appears in the display, then release both keys. |
| 2. | Press the ▲ key (8 times) until the word “ SPrr ” appears in the display. This is where you set the ramp rate in units of degrees/hour. First hold in the ‘*’ key, then while holding in the *’ key press the ▼ OR ▲ key until the desired ramp rate appears in the display, then let go of all the keys. Units are in degrees/hour. |
| 3. | Press the ▲ key once and the word “ SPrn ” will appear in the display. This function turns the ramping feature ON, OFF, or to Hold. First hold in the ‘*’ key, then while holding in the *’ key press the ▼ OR ▲ key until the desired setting appears in the display, then let go of all the keys. |
| 4. | Press the ▲ key once and the word “ Soak ” will appear in the display. This is where the soak time is set in units of Minutes. A soak time of ‘-- ‘ means to ‘soak forever’ (this setting is one below ‘0’). First hold in the ‘*’ key, then while holding in the *’ key press the ▼ OR ▲ key until the desired time appears in the display, then let go of all the keys. If a soak time is set, the controller display will alternate between showing the current reaction temperature and the word “ Stop ” when the soak time has expired to indicate that power has been turned off. |
| 5. | To exit programming mode, press and hold in both the ▼ and ▲ keys until the temperature appears in the display, then release both keys. |

Deactivating the Ramp-to-Setpoint Feature





| | |
|----|---|
| 1. | Press and hold in both the ▲ and ▼ keys on the front of the temperature meter until the word “ tunE ” appears in the display, then release both keys. |
| 2. | Press the ▲ key (9 times) until the word “ SPrn ” appears in the display. This function turns the ramping feature ON and OFF. First hold in the ‘*’ key, then while holding in the *’ key press the ▼ OR ▲ key until OFF appears in the display, then let go of all the keys. |
| 3. | To exit programming mode, press and hold in both the ▲ and ▼ keys until the temperature appears in the display, then release both keys. |

3.4 Temperature Sensor Input. Every controller is fitted with a specific *type* of thermocouple input and can only be used with a thermocouple of the same type. For the correct temperature to be displayed, the thermocouple type must match the receptacle type on the front of the controller (Figure 1; # 5). All thermocouples are color coded to show their type (Blue = type T; Yellow = type K; Black = type J). The color of the thermocouple plug must match the color of the receptacle on the front of the controller. If the thermocouple is broken or becomes unplugged, the error message "inPt" "FAiL" blinks in the temperature meter display and the controller stops heating.

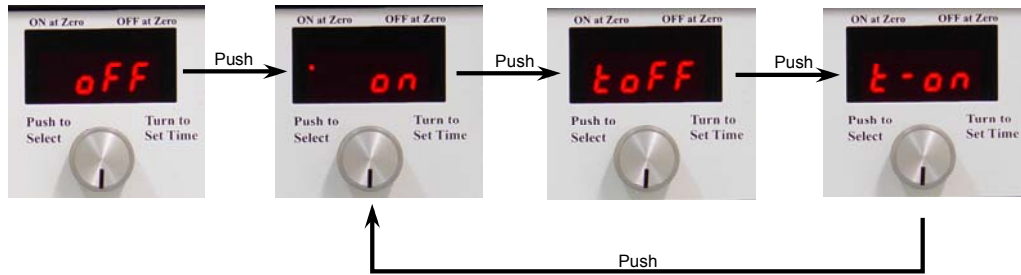
3.5 Timer Controls. The timer circuit works in conjunction with the digital meter to determine when power is applied to the heater. The digital meter is the actual temperature controller, the timer circuit only acts as a *gatekeeper* to determine if the digital meter (temperature controller) is allowed to apply power to the heater or not. By inserting the timer between the digital meter and the heater, the timer can turn heater power On or Off based on a user entered time.

| | |
|--|---|
| <p>When power to the controller is turned on, the timer defaults to the <i>Power Off</i> state as is indicated by the word Off in the display. In this state no power is applied to the heater. This is a safety feature that insures that power is not applied to a heater following recovery from a power failure.</p> |  |
|--|---|

| | |
|---|--|
| <p>The timer has 4 states. The timer cycles between the 4 states by pushing in on the silver timer knob momentarily. For example, push the timer knob once and the timer changes from the Off state to the On state, push it again and it changes to the toFF state. Repeatedly pushing the knob cause the time to cycle between its three normal states of On, toFF, and t-on. If the Power Reduction Circuit (Section 3.7) is set to the Heat Off position, the timer window always displays oFF. The four states of the timer circuit are explained below.</p> |  <p>NOTE: Pushing in on the timer knob quickly for about 1/4 second causes it to advance to the next state. Holding in the knob for 1 second changes to the mode where time is entered into the timer.</p> |
|---|--|

| | |
|---|---|
|  | <p>In the off state, no power is applied to the heater, even if the temperature meter calls for power to be applied. The controller always enters the off state when power is turned on or following recovery from a power failure. The controller also enters the off state when the power reduction circuit is set to the Heat Off position (see Section 3.7).</p> |
|  | <p>In the on state, the timer circuit applies power to the heater when the temperature meter calls for power to be applied. Whenever power is applied to the heater, the small LED dot on the left of the timer window is lit. Depending on the power needs of the heater, this dot may blink rapidly.</p> |
|  | <p>The “toFF” state (standing for <u>T</u>ime <u>O</u>ff) allows the user to enter the amount of time the controller should heat until heating is automatically turned off. While time is present in the timer, power is applied to the heater, when the time counts down to 0, heating is turned off. See the section below titled Heating for a Set Period of Time.</p> |
|  | <p>The “t-on” state (standing for <u>T</u>ime <u>O</u>n) allows the user to enter an amount of time to delay before applying power to the heater. While time is present in the timer, no power is applied to the heater even if the temperature meter calls for power to be applied, but when time counts down to 0, heat is turned on indefinitely. See the section below titled Delay Heating for a Set Period of Time.</p> |

Over View of the Timer Functions

The timer knob is a multi-function knob. When it's pushed in for 1/4 second it causes the timer to advance to the next function. When it's pushed in for 1 second it enters programming mode. In programming mode, the user enters time into the timer or locks the entered time into the timer which starts the program running (a running program can be aborted by holding in the timer knob for 1 second).

When in programming mode, rotating the knob in a clockwise direction increases the amount of time entered into the timer. Rotating the knob in a counter clockwise direction decrease the amount of time (when rotating in a counter clockwise direction, the timer rolls over from "00" to "59" minutes, when entering minutes, or from "00" to "99" hours, when entering hours).

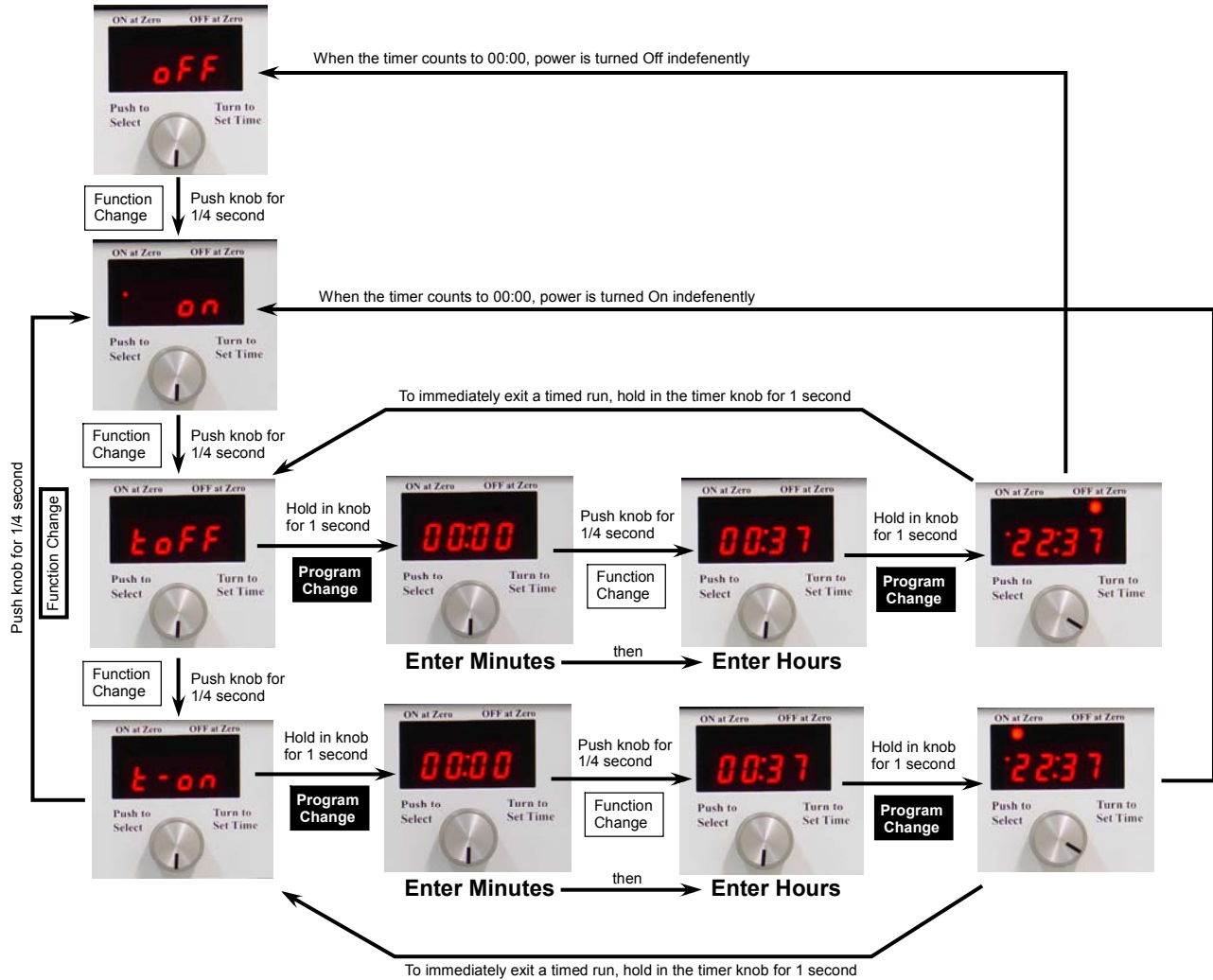

Heating for a Set Period of Time

In this mode, the user enters the amount of time to heat before turning heating off permanently. This is useful to heat a reaction or other lab instrument for a set period of time and then have the reaction stop heating automatically. While at this setting and while entering a time into the timer, no power is applied to the heater.



Step 1. When the timer displays “toFF”, holding in the timer knob causes the display to change to a clock showing 00 : 00. The left 2 digits are hours and the right 2 digits are minutes. The minutes digits are blinking which indicates that their value can be changed.

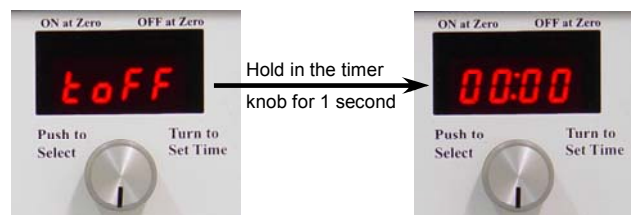

Step 2. To increase the number of minutes, rotate the timer knob to the right. To decrease the number of minutes, rotate the timer knob to the left.

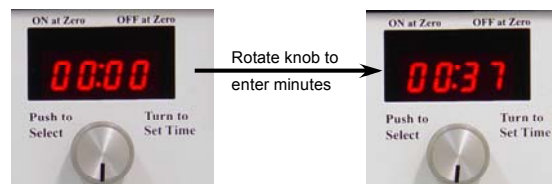

Step 3. To change the number of hours in the display, momentarily press the timer knob (1/4 second) and the hours digits begin to blink. To increase the number of hours, rotate the timer knob to the right. To decrease the number of hours, rotate the timer knob to the left.



Step 4. When the desired time is displayed, hold in the timer knob for 1 second to enter the time and start the timer. When the timer starts, the LED under the label “OFF at Zero” lights. This indicates that power to the heater will turn OFF when the timer counts down to zero.

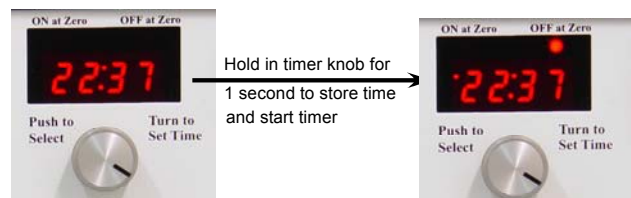

At any time, the timer program can be aborted by holding in the timer knob for 1 second. When this is done, the display changes to toFF. To turn on heating, push the timer knob twice until the display reads On.

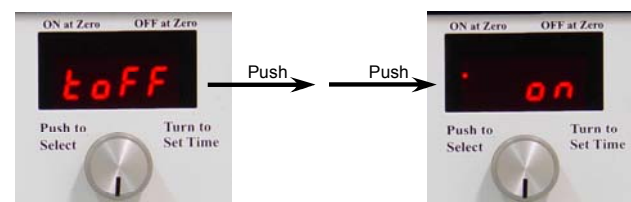

Delay Heating for a Set Period of Time

In this mode, the user enters an amount of time to delay before turning on power to the heater. This is useful to start heating a reaction or piece of equipment automatically at a specific time. While at this setting and while entering a time into the timer, no power is applied to the heater.



Step 1. When the timer displays “t-on”, holding the timer knob in for 1 second causes the display to change to a clock that shows 00 : 00. The left 2 digits are hours and the right 2 digits are minutes. The minutes digits are blinking which indicates that their value can be changed.

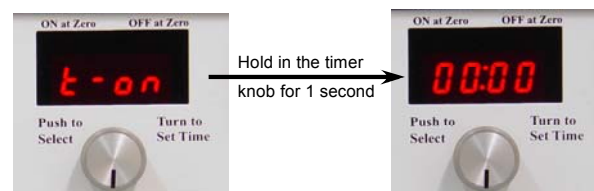

Step 2. To increase the number of minutes, rotate the timer knob to the right. To decrease the number of minutes, rotate the timer knob to the left.

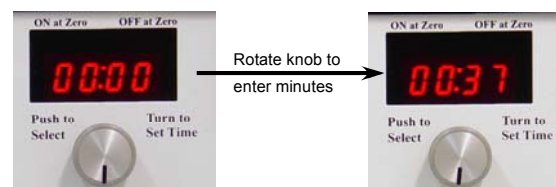

Step 3. To change the number of hours in the display, momentarily press the timer knob (1/4 second) and the hours digits begin to blink. To increase the number of hours, rotate the timer knob to the right. To decrease the number of hours, rotate the timer knob to the left.



Step 4. When the desired time is displayed, hold in the timer knob for 1 second to enter the time and start the timer. When the timer starts, the LED under the label “ON at Zero” lights. This indicates that power to the heater will turn ON when the timer counts down to zero.

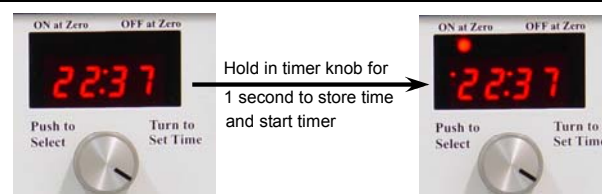

At any time, the timer program can be aborted by holding in the timer knob for 1 second. When this is done, the display changes to t-on. To turn on heating, push the timer knob until the display reads On.

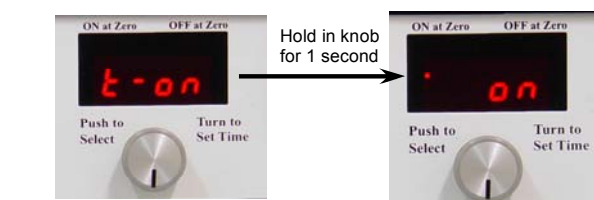

3.6 Over Temperature Protection Circuit. This circuit (7) disconnects power from the outlets if the process temperature exceeds the set point by 5° C or when power is restored following a power failure. Power remains disconnected until being manually reset by turning power to the controller off, and then back on. This circuit is armed when the alarm switch (7) is placed in either the Light or Alarm position and is off when placed in the Off position. When in the Off position this circuit **will not** disconnect power during an over temperature condition. If the alarm switch is set to Light and an over temperature condition occurs, the LED (8) lights and the timer window displays the word “HELP”. If the alarm switch is set to Alarm when an over temperature condition occurs, the LED (8) lights, an audible alarm sounds, and the timer window displays the word “HELP”. If a timer program is running when the over temperature condition occurs, the timer windows alternates between the word “HELP” and the time remaining in the timer program when the alarm occurred.

The high temperature limit (i.e. the limit that must be exceeded to trigger this circuit) is factory programmed for 5° C, but can be set lower or higher limits. Please contact J-KEM for assistance. If a small high temperature limit is programmed, such as 1° - 2°, the process should be allowed to stabilize at the set point before this circuit is turned on, since a small over shoot of the set point on initial warm-up should be expected.

3.7 Power Reduction Circuit. This circuit (10) limits the maximum output power delivered by the controller. It determines whether the controller heats at a very low (1-10 mL), low (10 - 100 mL), intermediate (50 - 500 mL), medium (300 mL - 2 L), or high (>2 L) power level. The power reduction circuit acts as a solid state variac.

The table to the right shows the maximum output power from the controller to the heater depending on the position of the power switch. The correct setting for this switch is the setting that supplies adequate power for the heater to heat to the set point in a reasonable period of time while not overpowering it.

| Front Panel Volume Range | Approx. % of Full Power |
|-----------------------------|----------------------------|
| 1 - 10 mL | 3 |
| 10 - 100 mL | 10 |
| 50 - 500 mL | 25 |
| 300 ml - 2 L | 50 |
| ≥ 2 L | 100 |

Heating Liquids. Each power level is associated with a volume range which acts as a guide when heating solutions with heating mantles. When solutions are heated with heating mantles set the power switch to the range that includes the volume of solution being heated [Note: this switch is set to the volume of solution, not the size of the flask]. For example to heat 250 ml of toluene to 80° C in a 1 L round bottomed flask choose the third power setting (50 - 500 ml) since the solution volume falls within this range. There are situations when a power level other than that indicated by the front panel should be used:

| Example | Power Setting | Explanation |
|---|-----------------------------|--|
| 80 ml toluene 100 ml flask 100 ml heating mantle SP = 80° C | 50 - 500 ml (25% power) | Organic solvents heated to $\approx 50 - 110^\circ \text{C}$ are set to the volume range on the front panel. When choosing between 2 power settings (i.e. 80 ml also falls within both the 10 - 100 ml range and the 50 - 500 ml range) choose the higher setting. |
| 80 ml collidine 100 ml flask 100 ml heating mantle SP = 170° C | 300 ml - 2 L (50% power) | Even though the solvent volume is less than the range of this power setting, it should be used because high temperatures require additional power. |
| 80 ml water 100 ml flask 100 ml heating mantle SP = 80° C | 300 ml - 2 L (50% power) | While the setting 50 - 500 ml would work, since the heat capacity of water is twice that of a typical organic solvent (1 cal/g/° K), a higher power setting can be used to compensate for the higher heat capacity. |
| 125 ml toluene 1 L flask 1 L heating mantle SP = 80° C | 10 - 100 ml (10% power) | When the heating mantle size is substantially larger ($\geq 5X$) than the volume being heated (i.e. the heating mantle has excess heating capacity for the volume being heated), a lower power setting gives better control. |
| 150 ml toluene 250 ml flask 250 ml heating mantle SP = 35° C | 10 - 100 ml (10% power) | Even though the solvent volume isn't included in this power setting, it should be used because low temperatures are better regulated with less power. |

Avoid switching between the different power levels while the controller is heating. Specifically, do not initially set the controller on a high power level to rapidly heat the solution, then decrease the power level to the correct setting as the solution approaches the set point. Changing power levels doesn't damage the controller, but it will reduce its heating performance.

Heating Equipment. Two factors need to be considered when heating equipment (ovens, hot plates, furnaces, HPLC columns, etc.), (1) placement of the temperature sensor (Section 2.4) and, (2) the appropriate power setting. The best guide to the correct power setting for various pieces of equipment is the researcher's experience. If your best guess is that the equipment needs 1/3 full power to heat to the set point, set the power switch on the 300 ml - 2 L setting (50% power. It's usually better to have too much power rather than too little). If the heater heats too slow, increase the power (set to the $>2 \text{ L}$ setting). If it heats too fast or has excessive overshoot, decrease the power (set to the 50 - 500 ml setting). If the amount of power seems to be adequate, but the heater doesn't heat with stability, the controller probably needs to be tuned (see Section 2). Section 3.8 shows the type of performance you should expect from the controller with different pieces of equipment.

3.8 Affect of Power Setting on Heating Profile.

The following graphs show the affect of selected power levels on heating performance in a variety of situations. Each example contains 1 optimal and 1 or 2 less optimal settings demonstrating use of the power reduction circuit.

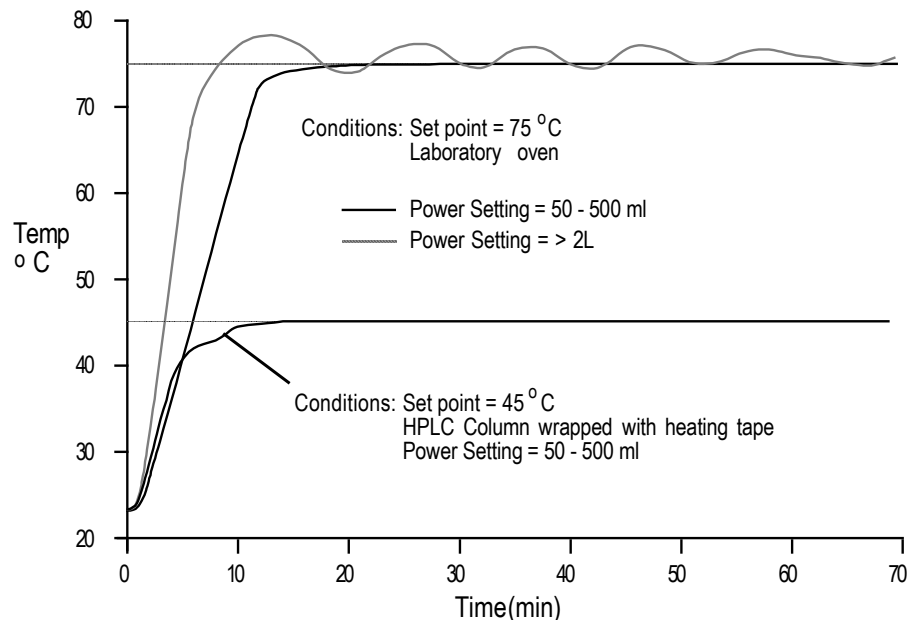

Graph 1

This graph shows typical heating profiles for a laboratory oven and an HPLC column. In the example of the oven the heating curves for 2 different power levels are shown. The 50 - 500 ml setting is the appropriate amount of power to heat to 75° C and thus results in a smooth heating curve. The > 2L power setting is too much power and results in oscillation around the set point.

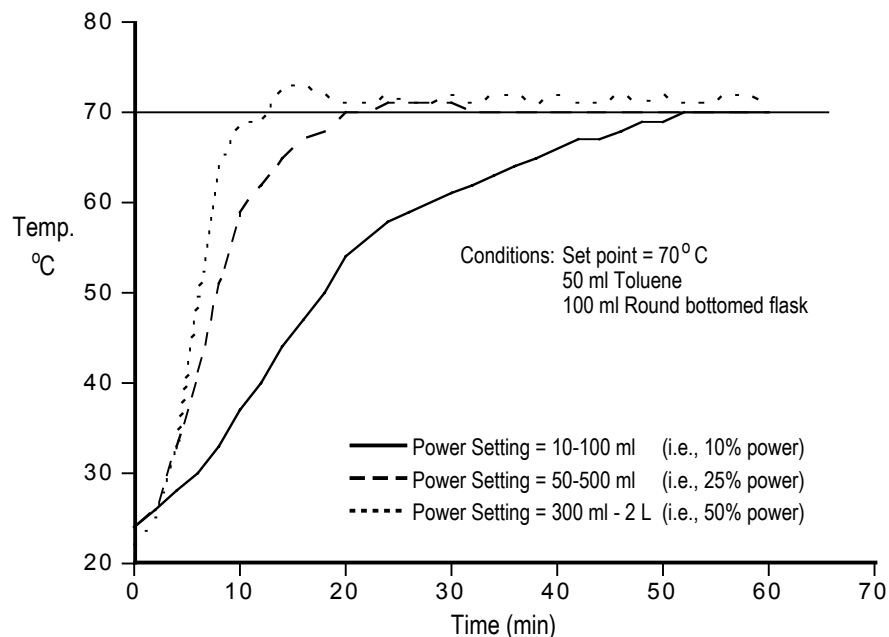

Graph 2

This graph shows the affect of different power settings when heating liquids with heating mantles. The 10 - 100 ml setting (10% power) is under powered and results in slow heating. The 300 ml - 2 L setting (50% power) is too much power and results in sporadic control. The controller adapts to a wide range of power settings. In this example the power is varied by a factor of 5X, nevertheless, reasonable control is maintained in each case.

Graph 3

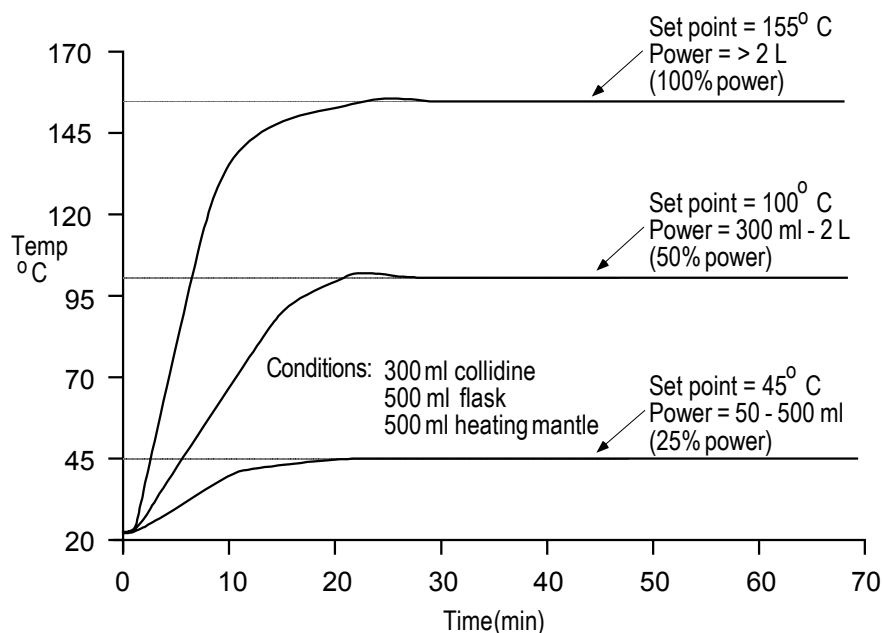

Another factor affecting the choice of power setting is the set point temperature. For set points near room temperature a low power level is adequate. For *average* temperatures (50 - 100°) the volumes printed on the front of the controller are a good guide. For high temperatures, the next higher power setting might be needed to supply the heater with additional power.

The power reduction circuit limits the total amount of power delivered to the heater. In this sense it works like a variac and can be used like one. If the heater isn't getting enough power, turn the power level up one notch, if it's getting too much power, turn it down.

3.9 Do's and Don'ts When Using Your Controller. The controller, heater and thermocouple form a closed loop feedback system (see Fig. 2 in Section 4.1). When the controller is connected to a heater, the feedback loop should not be broken at any point.

| | |
|--------------|--|
| Don't | remove either the thermocouple or heater from the solution without lowering the set point. With the thermocouple or heater separated from the solution, as the thermocouple cools the controller attempts to 're-heat' it by turning the heater on. Since this heat is never sensed by the thermocouple the controller heats continuously. If the thermocouple or heater are removed from solution, unplug the heater or preferably lower the set point below room temperature so no heat is called for. |
| Don't | use the controller to regulate an exothermic process. The controller has no capacity for cooling. If an exotherm is expected, it must be controlled in another manner. |
| Do | use an appropriate size flask and heater for the volume being heated. Use the smallest flask and heating mantle that accommodates the reaction. This ensures that the heating power of the heating mantle closely matches the volume being heated. This also allows the solution to radiate excess heat to minimize temperature overshoots. |
| Do | place the thermocouple directly in the solution. Place at least the first 1/4" of the thermocouple directly into the solution. If a corrosive mixture is heated, use a Teflon-coated thermocouple (or use the external thermocouple method; Section 4.2). |
| Do | avoid exposure of the controller to corrosive gases and liquids. The atmosphere of a research hood is corrosive to all electronics. Place the controller outside the hood away from corrosive gases. |

3.10 Resetting the Controller for Use With Heating Mantles.

If you want to use your controller with heating mantles after it's been tuned for a different style heater, rather than autotuning the controller with the heating mantle, J-KEM recommends that the controller be manually tuned by following the procedure below.

Procedure 1. Perform when using heating mantles with round bottomed flasks.

[This procedure takes about 2 minutes to perform]

| | |
|----|--|
| 1. | Press and hold in both the ▲ and ▼ keys on the front of the temperature meter until the word "tunE" appears in the display, then release both keys. |
| 2. | Press the ▲ key once and the word "bAnd" will appear in the display. First hold in the '*' key, then while holding in the '*' key press the ▼ or ▲ key until the value "10" appears in the display, then let go of all the keys. |
| 3. | Press the ▲ key once and the word "int.t" will appear in the display. First hold in the '*' key, then while holding in the '*' key press the ▼ or ▲ key until the value "10" appears in the display, then let go of all the keys. |
| 4. | Press the ▲ key once and the word "dEr.t" will appear in the display. First hold in the '*' key, then while holding in the '*' key press the ▼ or ▲ key until the value "50" appears in the display, then let go of all the keys. |
| 5. | Press the ▲ key once and the word "dAC" will appear in the display. First hold in the '*' key, then while holding in the '*' key press the ▼ or ▲ key until the value "3.0" appears in the display, then let go of all the keys. |
| 6. | Press the ▲ key once and the word "CyC.t" will appear in the display. First hold in the '*' key, then while holding in the '*' key press the ▼ or ▲ key until the value "30" appears in the display, then let go of all the keys. |
| 7. | Press and hold in both the ▼ and ▲ keys until the temperature appears in the display, then release both keys. |

3.11 Changing the Temperature Display Resolution

The controller is programmed to display temperature with 0.1° C resolution. The controller can be changed to 1° C resolution if by following the procedure below (the display can also be changed to read in ° F, call for information). There are two reasons to change the display resolution:

- 1) To enter a setpoint faster (the display scrolls 10X faster in 1° mode than in 0.1° mode).
- 2) To display temperatures above 999.9°.

| | |
|----|--|
| 1. | Press and hold in both the ▼ and ▲ keys on the front of the temperature meter until the word "tunE" appears in the display, then release both keys. |
| 2. | Press the ▼ key once and "LEVL" appears in the display. First hold in the '*' key, then while holding in the '*' key press the ▲ key until "2" appears in the display then let go of all the keys. |
| 3. | Press the ▲ key repeatedly until the word "diSP" appears in the display. First hold in the '*' key, then while holding in the '*' key press the ▼ or ▲ key until the value "1" [not "0.1"] appears in the display, then let go of all the keys. |
| 4. | Press and hold in both the ▼ and ▲ keys until the temperature appears in the display, then release both keys. |

3.12 Changing Between PID and ON/OFF Operating Modes. The controller can heat in either of 2 operating modes, PID (Proportional, Integral, Derivative) or ON/OFF mode. The difference between them is the way they supply power to the heater.

In ON/OFF mode (the simplest heating mode), the controller is ON when it's below the set point and OFF when above. The disadvantage of this mode is a large overshoot of the set point (5 - 30°) on initial warm up and oscillation of temperature around the set point thereafter. The reason for the overshoot is because the heater turns off only after crossing the set point and until the heater cools down the temperature continues to rise. This method works well for heaters that transfer heat rapidly (such as heat

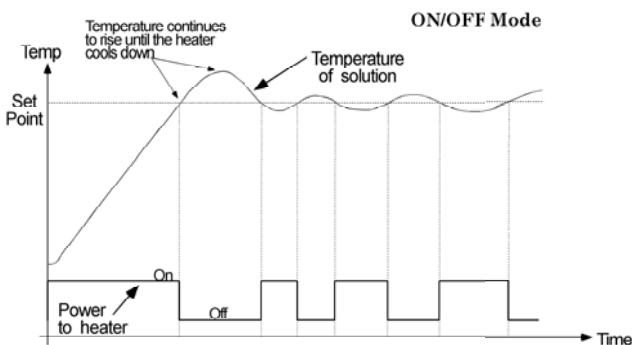

lamps), it's acceptable for heaters such as heating mantles ($\approx 5^\circ$ overshoot), but it's terrible for heaters that transfer heat slowly (vacuum ovens, heating blocks, etc.).

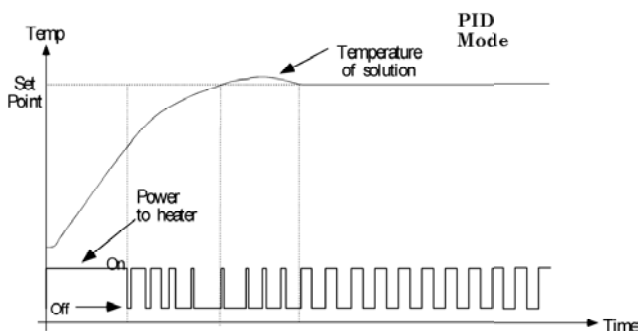

In PID mode the controller monitors the shape of the heating curve during initial warm up and decreases power to the heater before the set point is reached so that the solution reaches the set point with minimal overshoot. [Notice that the heater turns off for varying periods of time before the set point temperature is reached]. The second feature of PID mode is that it adjusts the percent of time the heater is on so that the set point is maintained precisely. The advantage of PID mode is that it delivers stable temperature control with any heater

from heat lamps to vacuum ovens. The disadvantage is that the controller must be properly tuned to the heater being used, whereas ON/OFF mode requires no tuning. Since both heating modes have their advantages (simplicity vs. accuracy), instructions to change the controller to ON/OFF mode are given below (though PID mode will probably give better results 95% of the time). The controller can be set back to PID mode by following Procedure 1 in Section 3.10.

- | |
|---|
| 1. Press and hold in both the ▲ and ▼ keys on the front of the temperature meter until the word "tunE" appears in the display, then let go of the buttons. |
| 2. Press ▲ until the word "CyC.t" appears in the display. |
| 3. While holding in the '*' key, press the ▼ key until the word "on.of" appears in the display. NOTE: if the display shows the letter "A" when the '*' keys is held in, press the ▲ key until "on.of" is in the display, then let go of all the keys. |
| 4. Press the ▼ key until the word "bAnd" appears in the display. While holding in the '*' key, press the ▼ key until the value "0.1" appears in the display, then let go of all the keys. |
| 5. Press and hold in both the ▲ and ▼ keys on the front of the controller until the temperature is displayed, then release both keys. |

Procedure to change controller to ON/OFF mode

The controller can be set back to PID control by following Procedure 1 in Section 3.10. To completely reset the controller to original factory settings, follow the procedure in the Appendix, Section II.

3.13 Troubleshooting.

| Problem | Cause | Corrective Action |
|--|--|--|
| Large over shoot of the set point ($> 3^{\circ}$) during initial warm-up or unstable temperature control | Power reduction circuit is set too high. | Set the power reduction circuit to a lower setting (see Section 3.7). |
| | Controller is not tuned for process being heated. | Tune the controller as outlined in Section 2. |
| The process heats too slowly. | Power reduction circuit is set too low. | Increase the power reduction circuit to the next higher setting (see Section 3.7). |
| | The heating power of the heater is too low. | Replace with higher power heater. For assistance contact J-KEM. |
| The controller does not come on. | Controller is unplugged. | Plug securely into wall outlet. |
| | The 3 amp fuse has blown. | Replace blown fuse. See Section 3.14. |
| The controller comes on, but does not heat. | The 15 amp fuse has blown | Replace blown fuse. See Section 3.14. |
| | The heater is broken. | To verify that the controller is functioning properly, place the power level switch on the $>2L$ setting and enter a set point of $100^{\circ}C$. Plug a light into the outlet of the controller, then wait 1 minute. If the light comes on the controller is working properly. |
| | The over temperature protection circuit is engaged. | Set the over temperature protection circuit to the OFF position then turn the Power Reduction Circuit to the OFF position. The over temperature protection circuit must be in the OFF position when the controller is initially turned on (see Section 3.6). |
| | The timer controls are set incorrectly. | See Section 3.5 |
| Controller blinks: "inPt" "FAiL" | The temperature sensor is unplugged, excessively corroded or broken. | Clean or replace broken sensor. |
| "-AL-" | The process temperature is hotter than the alarm temperature. | Correct the over temperature condition. |
| "PArk" | Controller has been placed in "Park" mode. | <ol style="list-style-type: none"> 1. Hold in both the ▲ and ▼ keys on the front of the J-KEM temperature meter until "tunE" appears in the display. 2. First hold in the "*" key, then while holding in the "*" key press the ▼ key until "OFF" appears. 3. Hold in the ▲ and ▼ keys until the temperature appears in the display. |
| "tunE" "FAiL" | Autotune routine failed. | Turn off controller for 10 seconds. See Section 2.2. |

| Problem | Cause | Corrective Action |
|--|--|---|
| <p>Displayed temperature is incorrect.</p> <p>[Note: Types 'K' and 'J' thermocouples display negative temperatures, but are not calibrated for them]</p> | The controller has not warmed-up. | The display temperature reads low when the controller is first turned on, but will self-correct as it warms up. The controller can be used immediately since it will warm up during the initial stages of heating. |
| | Wrong type of thermocouple is plugged into controller. | Thermocouples are color coded. Thermocouple plug and thermocouple receptacle must be the same color (see Section 3.4). |
| | Corroded thermocouple connections. | Clean plug on thermocouple and receptacle on controller with sandpaper or steel wool. |
| | Corroded thermocouple. | If the temperature-measuring end of the thermocouple is corroded, discard thermocouple. |
| | Temperature display offset needed. | <p>To enter a controller display offset:</p> <ol style="list-style-type: none"> 1. Turn on controller. Allow to warm up for 30 minutes. 2. Record displayed temperature. 3. Press both the ▲ and ▼ keys on the front of the temperature meter until "tunE" appears, then let go of the keys. 4. Press the ▼ key until "LEVL" appears. 5. First hold in the "*" key, then while holding in the "*" key press the ▲ key until "3" is showing in the display, then let go of all keys. 6. Press the ▲ key until "ZEro" is showing in the display. 7. Note the current display offset (this is the number blinking in the display). 8. Calculate the new offset temperature using the equation: $\begin{matrix} \text{New} & & \text{Current} \\ \text{Display} & = & \text{display offset} & - & \text{Displayed} & + & \text{Correct} \\ \text{Offset} & & \text{blinking in display} & & \text{temperature} & & \text{temperature} \end{matrix}$ <ol style="list-style-type: none"> 9. First hold in the "*" key, then while holding in the "*" key press the ▲ or ▼ keys until the new offset temperature is showing, then let go of all the keys. 10. Press the ▲ and ▼ keys until the temperature is displayed. |

3.14 Fusing. The controller is protected by a fast acting fuse designed specifically to protect solid state relays. This is the large fuse on the back panel of the controller. If this fuse is replaced **IT MUST BE REPLACED BY AN EXACT EQUIVALENT**, a Tron KAA-15 or Bussman KAX-15. One of these fuses, or an exact equivalent, must be used or a significant safety hazard will be created and will void the warranty.

Section 4: Application Notes

Supplemental application notes on the following topics are available by contacting J-KEM.

| Application Note | Subject |
|------------------|--|
| AN1 | How to heat oil baths with your controller. (Included in Appendix) |
| AN2 | Changing the controllers thermocouple type. |
| AN3 | Changing the heating outlet into a cooling outlet. |

4.1 Theory of How the Controller Works – Simply. For the purpose of explaining how the controller works, the example of a solution heated with a heating mantle is used. The principles are the same for all heater types.

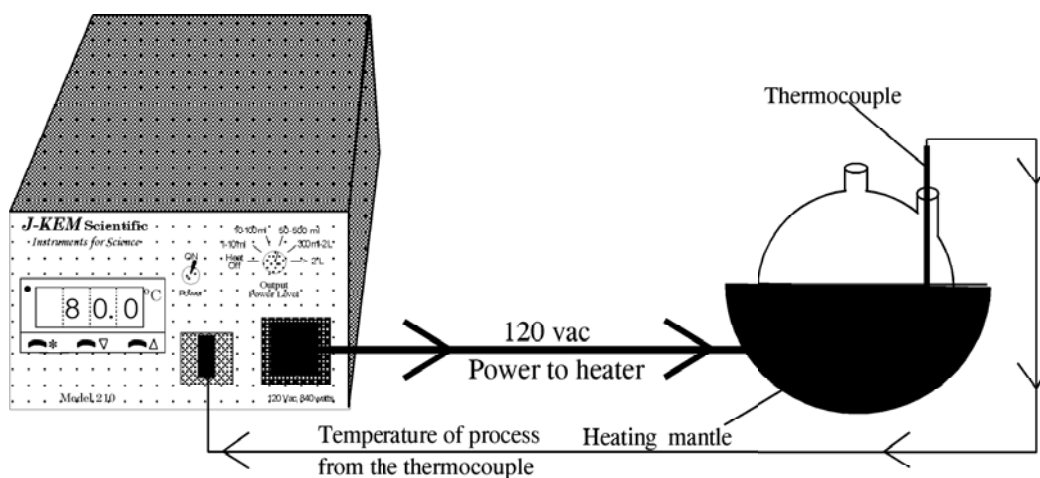

Figure 2

The controller, the heating mantle and the thermocouple form a closed loop feedback system. When the process temperature is below the set point, the controller turns the heating mantle on and then monitors the temperature rise of the solution. If a small rise results (indicating a large volume is being heated) the controller sets internal parameters appropriate for heating large volumes. If a large rise in temperature results, the controller responds by loading a set of parameters appropriate for heating small volumes. For the controller to work ideally, information needs to travel instantaneously around the feedback loop. That means that any power the controller applies to the heating mantle must reflect itself in an instantaneous temperature rise of the solution and the thermocouple. Unfortunately, this type of instantaneous heat transfer from the heating mantle to the solution to the thermocouple just doesn't occur. The delay time between when power is applied to the heating mantle and when the solution rises in temperature; and also the converse, when power is removed from the heating mantle and the solution temperature stops rising is the source of most controller errors. The reason for this can be seen in a simple example.

Imagine heating a gallon of water to 80° C in a 5 quart pan on an electric range. Placing the pan on the range and turning the heat to 'high' you'd observe a delay in heating while the range coil warmed-up. This delay might be a little annoying, but it's really no problem. The real problem comes as the water temperature approaches 80° C. If you turned the range off just as the water reached 80° C the temperature would continue to rise – even though all power had been disconnected

– until the range coil cooled down. This problem of overshooting the set point during initial warm-up is the major difficulty with process controllers. Overshooting the set point is minimized in two ways by your J-KEM controller – but first let's finish the range analogy. If you had turned the range off just as the water temperature reached 80° C, the final temperature probably would not exceed 82° C by the time the range coil cooled down, because the volume of water is so large. In most situations a 2° C overshoot is acceptable. But what if you were heating 3 tablespoons (45 mL) of water and turned the stove off just as the temperature reached 80° C. In this case, the final temperature would probably approach 100° C before the range cooled down. A 20° C overshoot is no longer acceptable. Unfortunately, this is the situation in most research heating applications. That is, small volumes (< 2 L) heated by very high efficiency heating mantles that contain large amounts of heat even after the power is turned off.

Your controller handles the problem of 'latent heat' in the heating mantle in two ways:

- 1) The controller measures the rate of temperature rise during the initial stages of heating. It then uses this information to determine the temperature at which heating should be stopped to avoid exceeding the set point. Using the range analogy, this might mean turning the power off when the water temperature reached 60° C and allowing the latent heat of the burner to raise the water temperature from 60 to 80° C. This calculation is done by the controller and is independent of the operator. The next feature of the controller is directly under operator control and has a major impact on the amount of overshoot on initial warm-up.
- 2) Again referring to the range analogy, you'd obtain better control when heating small volumes if the range had more than two power settings; Off and High. J-KEM's patented power reduction circuit (10) serves just this function. It allows the researcher to reduce the power of the controller depending on the amount of heat needed. This circuit can be thought of as determining whether the heating power is **Very low** (1-10 mL), **Low** (10-100 mL), **Intermediate** (50-500 mL), **Medium** (300 mL-2 L), or **High** (> 2 L). The proper power setting becomes instinctive after you've used your controller for awhile. For additional information see Section 3.7.

4.2 Controlling the Heating Mantle Temperature Directly. In a *normal* heating setup, the thermocouple is placed in the solution being heated. The controller then regulates the temperature of the solution directly. The thermocouple could alternately be placed between the heating mantle and the flask so that the controller regulates the temperature of the heating mantle directly, which indirectly regulates the temperature of the solution.

Advantages to this method include:

1. The temperature of any volume (microliters to liters) can be controlled.
2. Temperature control is independent of the properties of the material being heated (e.g., viscosity, solid, liquid, etc.).
3. Air and water sensitive reactions can be more effectively sealed from the atmosphere.

The temperature controller must be programmed for use with an external thermocouple before this procedure is used (see following procedure). The following step-by-step procedure programs the controller to regulate heating mantle temperature. If you switch back and use the controller with the thermocouple in solution, Procedure 1 in Section 2.3 will program the controller for heating mantles. For all other heaters, see tuning instructions in Section 2.

After the controller is reprogrammed, place a fine gage wire thermocouple (1/3 the size of kite string; available from J-KEM) in the bottom third of the heating mantle and fit the flask snugly on top so that the thermocouple is in intimate contact with the heating mantle. Set the power reduction circuit to the power level shown in the table at the right. Turn the controller on and enter the set point.

| Heating Mantle Size | Power Level |
|---------------------|-------------|
| 5 & 10 ml | 1-10 ml |
| 25 ml | 10-100 ml |
| 50 ml - 22 L | 50 - 500 ml |

For temperatures over 120 °C, the next higher power level may be necessary

Procedure to Load Tuning Parameters for External Thermocouples.

| | |
|----|--|
| 1. | Press and hold in both the ↓ and ↑ keys on the front of the temperature meter until the word “tunE” appears in the display, then release both keys. |
| 2. | Press the ↑ key once and the word “bAnd” will appear in the display. While holding in the ‘*’ key press the ↓ or ↑ key until the value “5” appears in the display, then release all keys. |
| 3. | Press the ↑ key once and the word “int.” will appear in the display. While holding in the ‘*’ key press the ↓ or ↑ key until the value “2” appears in the display, then release all keys. |
| 4. | Press the ↑ key once and the word “dEr.t” will appear in the display. While holding in the ‘*’ key press the ↓ or ↑ key until the value “5” appears in the display, then release all keys. |
| 5. | Press the ↑ key once and the word “dAC” will appear in the display. While holding in the ‘*’ key press the ↓ or ↑ key until the value “5.0” appears in the display, then release all keys. |
| 6. | Press the ↑ key once and the word “CyC.t” will appear in the display. While holding in the ‘*’ key press the ↓ or ↑ key until the value “5.0” appears in the display, then release all keys. |
| 7. | Press and hold in both the ↓ and ↑ keys until the temperature appears in the display, then release both keys. |

To return to using thermocouples in solution, perform Procedure 1 in Section 2.3.

4.3 Automatic Storage of Min/Max Temperatures The controller automatically records the minimum and maximum temperatures of a process by following the procedure below. These temperatures are updated continuously after the routine is started and cleared by turning the controller off. This procedure must be started every time you want to record temperatures.

| Procedure to Start Temperature Logging | |
|---|---|
| 1. | Press and hold in both the ↓ and ↑ keys on the front of the temperature meter until the word “tunE” appears in the display, then release both keys. |
| 2. | Press the ↓ key once and the word “LEUL” appears in the display. While holding in the ‘*’ key press the ↑ key until the value “3” appears in the display, then release all keys. |
| 3. | Press the ↑ key until the word “ChEy” appears in the display. While holding in the ‘*’ key press the ↑ key until “on” appears in the display, then release all keys. |
| 4. | Hold in both the ↓ and ↑ keys until the temperature appears in the display, then release both keys. Automatic temperature logging is now on and will remain on until the controller is turned off or logging is turned off manually ↑ by repeating this procedure except in Step 3 pressing the ↑ key until the word “off” appears. |
| Procedure to Read Minimum and Maximum Temperatures | |
| 1. | Press and hold in both the ↓ and ↑ keys on the front of the temperature meter until the word “tunE” appears in the display, then release both keys. |
| 2. | Press the ↓ key once and the word “LEUL” appears in the display. While holding in the ‘*’ key press the ↑ key until the value “3” appears in the display, then release all keys. |
| 3. | Press the ↑ key until the word “rEAd” appears in the display. The “rEAd” screen displays 3 parameters. <ol style="list-style-type: none"> 1. Variance (the difference between the highest and lowest logged temperatures) Hold in the ‘*’ key and the display will alternate between “UAr0” and number of degrees of variance. 2. High Temperature (the highest temperature since the logging option was turned on). While holding in the ‘*’ key press the ↑ key once and the display will alternate between “hi 0” and the highest recorded temperature. 3. Low Temperature. While holding in the ‘*’ key press the ↑ key once and the display will alternate between “Lo 0” and the lowest recorded temperature. <p>The High and Lo temperatures can be examined as often as you like since updating and monitoring continues until the monitor is stopped by turning the controller off.</p> |
| 4. | Press and hold in both the ↓ and ↑ keys until the temperature appears in the display, then release both keys. |

Appendix

I. Using the Controller With an Oil Bath Application Note #1

Using your 200-Series controller with oil baths rated for less than 120 volt operation is generally not recommended. J-KEM manufactures a 400-Series controller designed for use with all oil baths and is recommended for this application. The 200-Series controller can be used with an oil bath rated for 120 volt operation without any special setup, just use this oil bath like you would a heating mantle, but be sure to put the thermocouple in the oil, not the flask. The 200-Series controller can be used safely with oil baths that are not rated for 120 volt operation if the instructions in this application note are followed. An alternative to oil baths is outlined in Point 2 below.

1. The following procedure allows your controller to regulate the temperature of an oil bath.
 - A. **Set the output power level on the controller to the >2 L setting (REQUIRED).**
 - B. Place the thermocouple in the oil bath (not too close to the heating coil).
 - C. Plug a variac into the heating receptacle of the controller and connect the oil bath to the variac.
 - D. Adjust the variac to deliver a voltage slightly above the voltage you normally would use to heat the oil bath.
 - E. Enter the desired temperature into the controller. The controller will now regulate the temperature of the oil bath.

In some unusual cases, the controller may need to be autotuned for the oil bath (see User's Manual) but this is discouraged unless you'll be using the oil bath frequently.

2. If you frequently heat reactions using oil baths, we recommend J-KEM's 400-Series oil bath controller.

If the reason for using an oil bath is that a small volume is being heated, and you want to use your 200-Series controller for the job, you have a second option. J-KEM sells heating mantles for small volumes (5, 10, 25, 50 ml) which can be plugged directly into the temperature controller. Your controller regulates volumes as small as 1 ml in a 5 ml flask using a 5 ml heating mantle. If you need to heat even smaller volumes, your User's Manual describes a technique for heating microliters ("Controlling the Heating Mantle Temperature Directly"; in Section 4). The advantage of this option is that it eliminates the mess and safety hazards associated with oil baths. Accessories for regulating the temperature of small volumes are available from J-KEM including small volume heating mantles and micro thermocouples.

Call if you have any concerns or would like to discuss your application with a technical representative.

Accessories for Heating Small Volumes Available From J-KEM

| | |
|--|------------------------------|
| Heating Mantles | All sizes from 5 ml to 50 L. |
| Teflon Coated Microscale Thermocouples | See Catalog. |
| Thermocouples hermetically sealed in various size hypodermic needles | See Catalog |

II. Safety Considerations and Accurate Temperature Control

For safety critical and non-typical organic reactions (especially polymeric reactions) or for use with heaters other than heating mantles the user must either 1) monitor the reaction closely to verify the tuning parameters are appropriate for the current application, or 2) autotune the controller for the application. For any safety critical or high value reaction, call J-KEM to discuss your application with an engineer prior to beginning.

Your J-KEM controller is capable of regulating virtually any application to $\pm 0.1^\circ\text{C}$ if the controller is tuned to the application being heated. Since it's possible that the tuning parameters are not set correctly for your application, the user must monitor a new reaction to verify the controller's operation. A short primer on tuning is presented below, a more detailed explanation is presented in Sections 2.1 and 4.1.

Tuning is the process that matches the control characteristics of the controller to the heating characteristics of the process being controlled. The controller uses a PID (Proportional, Integral, Derivative) algorithm to regulate heating. Each of the terms in the PID equation have a constant that *scales* the equation to the process being heated. These constants (plus two other related terms) are collectively known as the 'tuning constants' and for the most part they are expressed in units of time, since they represent delay times, rate of heat transfer times, and rate of error accumulation. The relative value of each constant depends on the physical characteristics of the process being heated. For example, for the same amount of input power, the rate of heat transfer is twice as high for hexane as compared to water, since the coefficient of heat for hexane is $0.54\text{ calories/g/}^\circ\text{C}$ and water is $1.0\text{ calorie/gram/}^\circ\text{C}$. That means that 1000 watt-seconds of input power will raise the temperature of 10 g of hexane 44°C while the same amount of power causes a 24°C rise in water. In theory, the tuning constants needed to heat hexane are different from those to heat water. Fortunately, your J-KEM controller is self-adaptive and is able to adjust its heating characteristics for different solvents such as hexane and water. Even with the controller's self-adaptive algorithms, the tuning constants have to be reasonably close to a proper set or the controller will not produce stable temperature control (see Section 2.1).

When a controller is shipped, the default set of tuning constants loaded into the controller are those appropriate for heating *typical* organic reactions (i.e., small molecule chemistry in low boiling ($< 160^\circ\text{C}$) organic solvents) using heating mantles, since this is the most common application for J-KEM controllers. **Since it's impossible for J-KEM to predict the application the controller will be used for, the researcher must be aware of the possibility that the tuning constants loaded into the controller may not be a set that results in stable temperature control. It's the researcher's responsibility to monitor the temperature regulation of a reaction.** If you encounter a process that your J-KEM controller does not heat with stability, you have two resources.

Autotune Feature. Your controller has an autotune feature that when turned on (see Sections 2.1 & 2.2) automatically determines the proper tuning constants for your application and then loads them into memory for future use.









J-KEM Technical Assistance. If you have an application you wish to discuss, call us, we're always anxious to help our users.

For an additional description of the PID algorithm and the concept of tuning, see Sections 2 and 4.1.

III. Resetting the Controller to Original Factory Settings

J-KEM manufactures the most technically advanced temperature controller available and should give consistently flawless control. If you have difficulty with your controller, a good place to start to correct the problem is by loading the original factory settings. If problems persist, our Engineering department will help you resolve the problem. The factory settings of a J-KEM controller are: 0.1° C resolution, PID control with tuning parameters for a heating mantle, high temperature alarm turned on, and a thermocouple offset entered at the time of original calibration.

Procedure to Reset the Controller to Original Factory Settings

| 1. | Set the Over Protection circuit (12) to the OFF position. Press and hold in both the ▼ and ▲ keys on the front of the temperature meter until the word “tunE” appears in the display, then release both keys. | | | | | | | | |
|---|---|---|-----------------|---------------|--|-----------------|--|----------------|--|
| 2. | Press the ▼ key until “LEVL” appears in the display. Next, hold in the ‘*’ key, then while holding in the ‘*’ key press the ▲ key until “3” appears in the display. Let go of all the keys. | | | | | | | | |
| 3. | Press the ▲ key until “rSET” appears in the display. Next, hold in the ‘*’ key, then while holding in the ‘*’ key press the ▲ key until the word “All” appears in the display. Let go of all the keys. | | | | | | | | |
| 4. | Press and hold in both the ▼ and ▲ keys until the word “inPt” appears in the display, then release both keys. The value that needs to be entered depends of the type of thermocouple receptacle your controller was shipped with. Determine the thermocouple type below. <table style="margin-left: auto; margin-right: auto;"> <thead> <tr> <th style="text-align: center;">Color of thermocouple receptacle (Fig 1; # 9)</th> <th style="text-align: center;">Value to enter:</th> </tr> </thead> <tbody> <tr> <td style="text-align: center;">Blue (type T)</td> <td style="text-align: center;">“tc  ”</td> </tr> <tr> <td style="text-align: center;">Yellow (type K)</td> <td style="text-align: center;">“tc  ”</td> </tr> <tr> <td style="text-align: center;">Black (type J)</td> <td style="text-align: center;">“tc  ”</td> </tr> </tbody> </table> <p>First hold in the ‘*’ key, then while holding in the ‘*’ key press the ▲ key until the value from the table above appears in the display. Let go of all the keys. NOTE: Many of the patterns for this parameter look similar, be careful to select the exact pattern shown above.</p> | Color of thermocouple receptacle (Fig 1; # 9) | Value to enter: | Blue (type T) | “tc  ” | Yellow (type K) | “tc  ” | Black (type J) | “tc  ” |
| Color of thermocouple receptacle (Fig 1; # 9) | Value to enter: | | | | | | | | |
| Blue (type T) | “tc  ” | | | | | | | | |
| Yellow (type K) | “tc  ” | | | | | | | | |
| Black (type J) | “tc  ” | | | | | | | | |
| 5. | Press the ▲ key once and “unit” will appear in the display. Next, hold in the ‘*’ key, then while holding in the ‘*’ key press the ▲ key until the value “0 C” appears in the display. Let go of all the keys. | | | | | | | | |
| 6. | Press the ▲ key once and the word “SP1.d” appears in the display. Next, hold in the ‘*’ key, then while holding in the ‘*’ key press the ▲ key until the value “SSd” appears in the display. Let go of all the keys. | | | | | | | | |
| 7. | Press in both the ▼ and ▲ keys until the temperature appears in the display (the word “PArk” also appears), then release both keys. Hold in the ‘*’ key then press the ▲ key until a value > 100 is entered. Let go of all the keys. | | | | | | | | |
| 8. | Hold in both the ▼ and ▲ keys on the front of the temperature meter until the word “tunE” appears in the display, then release both keys. | | | | | | | | |
| 9. | Press the ▲ key once and the word “bAnd” will appear in the display. Next, hold in the ‘*’ key, then while holding in the ‘*’ key press the ▲ key until the value “10” appears in the display. Let go of all the keys. | | | | | | | | |
| 10. | Press the ▲ key once and the word “int.t” will appear in the display. Next, hold in the ‘*’ key, then while holding in the ‘*’ key press the ▲ key until the value “10” appears in the display. Let go of all the keys. | | | | | | | | |
| 11. | Press the ▲ key once and the word “dEr.t” will appear in the display. Next, hold in the ‘*’ key, while holding in the ‘*’ key press the ▲ key until the value “50” appears in the display. Let go of all the keys. | | | | | | | | |
| 12. | Press the ▲ key once and the word “dAC” will appear in the display. Next, hold in the ‘*’ key, then while holding in the ‘*’ key press the ▲ key until the value “3.0” appears in the display. Let go of all the keys. | | | | | | | | |
| 13. | Press the ▲ key once and the word “CyC.t” will appear in the display. Next, hold in the ‘*’ key, then while holding in the ‘*’ key press the ▲ key until the value “30” appears in the display. Let go of all the keys. | | | | | | | | |
| 14. | Press the ▼ key until the word “LEVL” appears in the display. | | | | | | | | |
| 15. | First hold in the ‘*’ key, then while holding in the ‘*’ key press the ▲ key until “2” appears in the display. Let go of all the keys. | | | | | | | | |
| 16. | Press the ▲ key until “SP2.A” appears in the display. Next, hold in the ‘*’ key, then while holding in the ‘*’ key press the ▲ key until the word “dU.hi” appears in the display. Let go of all the keys. | | | | | | | | |
| 17. | Press the ▲ key until “diSP” appears in the display. Next, hold in the ‘*’ key, then while holding in the ‘*’ key press the ▼ or ▲ key until the value “0.10” appears in the display. Let go of all the keys. | | | | | | | | |
| 18. | Press the ▲ key until “Lo.SC” appears in the display. Next, hold in the ‘*’ key, then while holding in the ‘*’ key hold in the ▼ key until the number in the display stops changing (this will be “0” or “-50” or “-199.9” depending on thermocouple type). Let go of all the keys. | | | | | | | | |
| 19. | Press the ▼ key until the word “LEVL” appears in the display. | | | | | | | | |
| 20. | First hold in the ‘*’ key, then while holding in the ‘*’ key press the ▲ key until “3” appears in the display. Let go of all the keys. | | | | | | | | |
| 21. | Press the ▲ key until “rEU.d” appears in the display. Next, hold in the ‘*’ key, then while holding in the ‘*’ key press the ▲ key until the value “1r.2r” appears in the display. Let go of all the keys. | | | | | | | | |
| 22. | Press the ▲ key until “ZEro” appears in the display. Next, hold in the ‘*’ key, then while holding in the ‘*’ key press the ▼ or ▲ key until the value _____ appears in the display. Let go of all the keys. | | | | | | | | |
| 23. | Press the ▲ key until the word “VER” appears in the display. Next, hold in both the ▼ and ▲ keys for about 8 seconds until the word “LoCY” appears in the display. Let go of all the keys. | | | | | | | | |
| 24. | Press the ▼ key until the word “no.AL” appears in the display. Next, hold in the ‘*’ key, then while holding in the ‘*’ key press the ▲ key until the value “on” appears in the display. Let go of all the keys. | | | | | | | | |
| 25. | Press the ▼ key until the word “LEVL” appears in the display. | | | | | | | | |
| 26. | First hold in the ‘*’ key, then while holding in the ‘*’ key press the ▼ key until “1” appears in the display. Let go of all the keys. | | | | | | | | |
| 27. | Press the ▲ key until “SEt.2” appears in the display. Next, hold in the ‘*’ key, then while holding in the ‘*’ key press the ▲ key until the value “5.0” appears in the display. Let go of all the keys. | | | | | | | | |
| 28. | Press and hold in both the ▼ and ▲ keys until the temperature appears in the display, then release both keys. | | | | | | | | |